



Class I • Class II • Type 1 • Type 2

Location of Use: Sub-Distribution Boards  
 Mode of Protection: (DC+) - PE, (DC-) - PE  
 Surge Ratings:  $I_n = 20 \text{ kA}$  (8/20  $\mu\text{s}$ )  
 IEC/EN/UL Category: Class I+II / Type 1+2  
 Protective Elements: High Energy MOV  
 Housing: Pluggable Design  
 Compliance: IEC 61643-31:2018  
 EN 50539-11:2013+A1:2014

### ■ Technical Data

IEC Electrical		1500
Nominal AC Voltage	$U_o / U_n$	1500 V
Maximum Continuous Operating Voltage (DC)	$U_c$	1500 V
Nominal Discharge Current (8/20 $\mu\text{s}$ )	$I_n$	20 kA
Maximum Discharge Current (8/20 $\mu\text{s}$ )	$I_{max}$	40 kA
Impulse Discharge Current (10/350 $\mu\text{s}$ )	$I_{imp}$	6.25 kA
Voltage Protection Level	$U_p$	5.6 kV
Response Time	$t_A$	< 25 ns
Back-Up Fuse (max)		125 A gL / gG
Short-Circuit Current Rating (AC)	$I_{SCCR}$	25 kA / 50 kA
Mechanical & Environmental		
Operating Temperature Range	$T_a$	-40°F to +158°F [-40°C to +70°C]
Permissible Operating Humidity	RH	5%...95%
Atmospheric pressure and altitude		80k Pa ... 106k Pa / -500 m.....2000 m
Terminal Screw Torque	$M_{max}$	39.9 lbf-in [4.5 Nm]
Conductor Cross Section (max)		2 AWG (Solid, Stranded) / 4 AWG (Flexible) 35 mm <sup>2</sup> (Solid, Stranded) / 25 mm <sup>2</sup> (Flexible)
Mounting		35 mm DIN Rail, EN 60715
Degree of Protection		IP 20 (built-in)
Housing Material		Thermoplastic: Extinguishing Degree UL 94 V-0
Thermal Protection		Yes
Operating State / Fault Indication		Green ok / Red defect
Remote Contacts (RC)		Optional
RC Switching Capacity		AC: 250V / 0.5 A; DC: 250V / 0.1 A; 125V / 0.2 A; 75V / 0.5 A
RC Conductor Cross Section (max)		16 AWG (Solid) / 1.5 mm <sup>2</sup> (Solid)

# LY1-C40PV/3(S) 1500V(D4)

Pluggable Multi-Pole SPD



## Internal Configuration

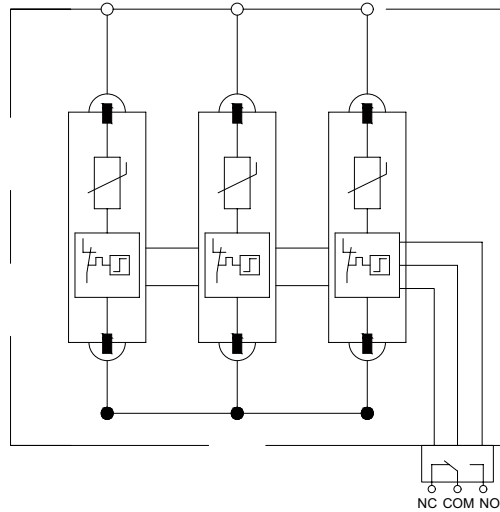

## Dimensions & Packaging

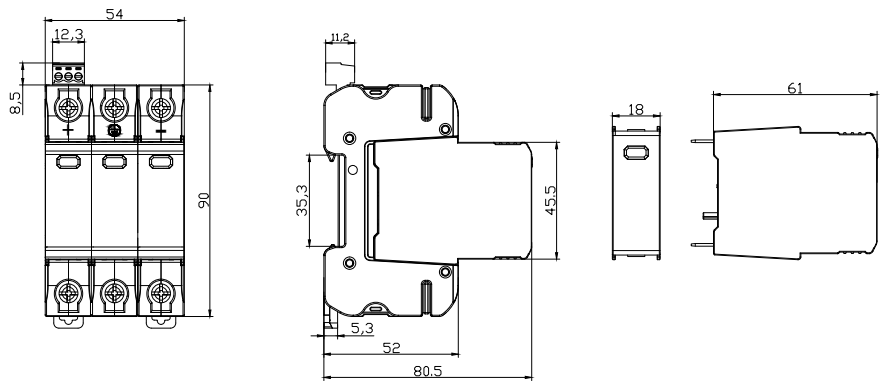

## Connection Diagram

